



The Mercedes-Benz Vito.

Panel and crew van models.

Prices effective from January 2024 for March production.

Mercedes-Benz





RETURN TO START

Contents

> Model overview	3
> Trims	
Vito Panel Van PRO	4
Vito Panel Van SELECT	5
Vito Crew Van PRO	6
Vito Crew Van SELECT	7
> Colours and Upholstery	8
> Equipment	9
> Engine and gearbox	16
> Fuel consumption	17
> Weights and payloads	18
> Dimensions	19
> List prices	23
> Mercedes-Benz Finance Options	24
> Mercedes me connectivity	25
> Approved Used	26
> Service24	27

Please note

This document provides information about the model range line-up and specifications of the Vito. It also contains key details about options, economy and performance of all variants. Details are correct at time of publication and are subject to revision. Any images used in this document may not reflect UK specification and are for illustrative purposes only. Images may show optional equipment which does not form part of UK standard specification.

The Mercedes-Benz Vito.



RETURN TO START

2 van models:



Panel Van – 3 seats



Crew Van – 6 seats



Panel Van PRO



Panel Van SELECT



Crew Van PRO



CREW Van SELECT

2 trims:

Discover more about the other Mercedes-Benz Vito models in our range:

- ▶ [The Vito Tourer](#)
- ▶ [The eVito](#)

Vito Panel Van PRO	Vito Panel Van SELECT	Vito Crew Van PRO	Vito Crew Van SELECT	Colours and upholstery	Equipment	Engine & gearbox	Fuel consumption	Weights and payloads	Dimensions	List prices	Mercedes me connectivity	Approved Used	Service24
--------------------	-----------------------	-------------------	----------------------	------------------------	-----------	------------------	------------------	----------------------	------------	-------------	--------------------------	---------------	-----------

The Vito Panel Van PRO.

Standard features include:

Interior

- TEMPATIC air conditioning
- Comfort driver's seat
- Double co-driver's seat
- Adjustable steering wheel, reach and rake
- Modern instrument cluster with 5.5" TFT colour display
- Locking glovebox
- Multifunction steering wheel

Exterior

- 17" steel wheels
- Full wheel cover
- Summer tyres
- Heated, electrically adjustable mirrors

Technology

- MBUX Multimedia System with 10.25" Touchscreen
- 2-way loudspeakers in front

Safety and Driver Assistance Systems

- Driver and co-driver airbag
- Active Brake ASSIST
- Anti-theft protection package
- ATTENTION ASSIST
- Blind spot assist
- Headlight assistant
- Emergency call system
- Double locks
- Reversing camera
- Cruise control

Load Area

- Wood flooring
- Full-length partition
- Twin side loading doors
- Rear 'barn' style doors, 180° opening
- Weldnuts in sidewall for conversions

All Vitos now offer a gross vehicle weight of 3.0t, increasing payload capability.

From £32,850 (exc. VAT)*

* Based on a Vito 114 Van L2 PRO.

• 2 lengths available

- L2: 5,140mm
- L3: 5,370mm

• 2 transmissions available

- 6-speed (manual)
- 9G-TRONIC PLUS (automatic)

➤ [Arrange a test drive at your nearest Dealership](#)



RETURN TO START

Plastic bumpers included as standard.



The Mercedes-Benz Vito

4

Vito Panel Van PRO	Vito Panel Van SELECT	Vito Crew Van PRO	Vito Crew Van SELECT	Colours and upholstery	Equipment	Engine & gearbox	Fuel consumption	Weights and payloads	Dimensions	List prices	Mercedes me connectivity	Approved Used	Service24
--------------------	-----------------------	-------------------	----------------------	------------------------	-----------	------------------	------------------	----------------------	------------	-------------	--------------------------	---------------	-----------

The Vito Panel Van SELECT.

Upgrade from PRO to SELECT to get all of the additional equipment listed below:

Interior

- Leather steering wheel
- Chrome interior appointments package
- Grab handles for driver's and co-driver's doors
- Illuminated vanity mirrors for sun visors
- Lighting for footwell, front
- Interior and ambient lighting
- LED light strip in load compartment

Exterior

- 17" alloy wheels (5 twin-spoke design)
- Chromed radiator grille
- Colour-coded front and rear bumpers
- MULTIBEAM LED with Highbeam assist PLUS
- Electrically folding wing mirrors
- Metallic paint
- Exit lamps

Safety and Driver Assistance Systems

- Parking package with reversing camera

Technology

- 9G-TRONIC Auto transmission
- Smartphone integration package

All Vitos now offer a gross vehicle weight of 3.0t, increasing payload capability.

From **£41,690** (exc. VAT)*

* Based on a Vito 116 Van L2 SELECT.

• 2 lengths available

- L2: 5,140mm
- L3: 5,370mm

• 1 transmission available

- 9G-TRONIC PLUS (automatic)

➤ [Arrange a test drive at your nearest Dealership](#)



The Mercedes-Benz Vito

5

The Vito Crew Van PRO.

Standard features include:

Interior

- TEMPOMATIC air conditioning
- Comfort driver's seat
- Double co-driver's seat
- 3-seat bench 1st row with folding outer seat
- Adjustable steering wheel, reach and rake
- Multifunction steering wheel
- Leather steering wheel
- Modern instrument cluster with 5.5" TFT colour display
- Locking glovebox

Exterior

- 17" Alloy wheels (20 spoke design)
- Chromed radiator grille
- Colour-coded front and rear bumpers
- Summer tyres
- Exterior mirror heated and electr. adjustable
- Window in tailgate with wipe/wash system

Load Area

- Plastic flooring, TPO, in passenger compartment
- Interior panelling higher execution

Load Area (cont.)

- Twin side loading doors
- Tailgate
- Grab handles in rear
- Weldnuts in sidewall for conversions

Safety and Driver Assistance Systems

- Driver and Co-driver airbag
- Active Brake ASSIST
- ATTENTION ASSIST
- Headlight assistant
- Reversing camera
- Blind spot assist
- Cruise control
- Anti-Theft protection package
- Double locks
- Emergency call system
- Headlight assistant

Technology

- MBUX multimedia system with 10.25" Touchscreen
- 2-way loudspeakers, front and rear

All Vitos now offer a gross vehicle weight of 3.0t, increasing payload capability.

From £40,385 (exc. VAT)*

* Based on a Vito 116 Crew Van L2 PRO.

• 2 lengths available

L2: 5,140mm
L3: 5,370mm

• 1 transmission available

9G-TRONIC PLUS (automatic)

➤ [Arrange a test drive at your nearest Dealership](#)



RETURN TO START



The Mercedes-Benz Vito

6

Vito Panel Van PRO	Vito Panel Van SELECT	Vito Crew Van PRO	Vito Crew Van SELECT	Colours and upholstery	Equipment	Engine & gearbox	Fuel consumption	Weights and payloads	Dimensions	List prices	Mercedes me connectivity	Approved Used	Service24
--------------------	-----------------------	-------------------	----------------------	------------------------	-----------	------------------	------------------	----------------------	------------	-------------	--------------------------	---------------	-----------

The Vito Crew Van SELECT.

Upgrade from PRO to SELECT to get all of the additional equipment listed below:

Interior

- Chrome interior appointments package
- Grab handles for driver's and co-driver's doors
- Illuminated vanity mirrors for sun visors
- Automatically dimming interior mirror
- Lighting for footwell, front
- Interior and ambient lighting

Exterior

- 17" Alloy wheels (5 twin-spoke design)
- LED tail lamps, brake lamps and indicators
- MULTIBEAM LED with Highbeam Assist PLUS
- Electrically folding wing mirrors
- Exit lamps
- Metallic paint

Safety and Driver Assistance Systems

- Parking package with reversing camera

Technology

- Smartphone integration package

All Vitos now offer a gross vehicle weight of 3.0t, increasing payload capability.

From £44,535 (exc. VAT)*

* Based on a Vito 119 Crew Van L2 SELECT.

• 2 lengths available

- L2: 5,140mm
- L3: 5,370mm

• 1 transmission available

- 9G-TRONIC PLUS (automatic)

➤ [Arrange a test drive at your nearest Dealership](#)



The Mercedes-Benz Vito

Vito Panel Van PRO	Vito Panel Van SELECT	Vito Crew Van PRO	Vito Crew Van SELECT	Colours and upholstery	Equipment	Engine & gearbox	Fuel consumption	Weights and payloads	Dimensions	List prices	Mercedes me connectivity	Approved Used	Service24
--------------------	-----------------------	-------------------	----------------------	------------------------	-----------	------------------	------------------	----------------------	------------	-------------	--------------------------	---------------	-----------

Colours and upholstery.



RETURN TO START

Solid paints



Arctic White
(Standard for PRO)

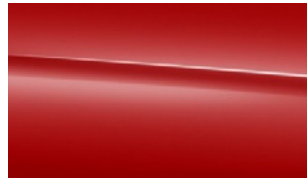

Jupiter Red



Navy Blue

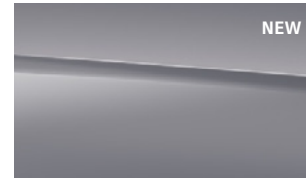

Alpine Grey



Vintage Blue

Metallic paints

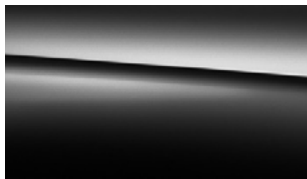

Obsidian Black



Hightech Silver

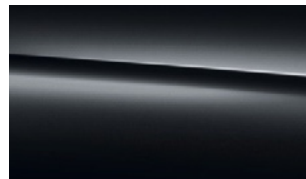

Graphite Grey

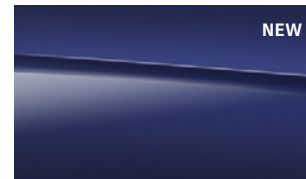

Sodalite Blue

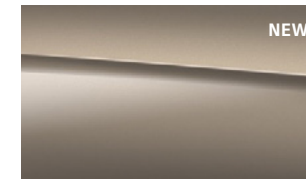

Kalahari Gold



Hyacinth Red

Interior upholstery

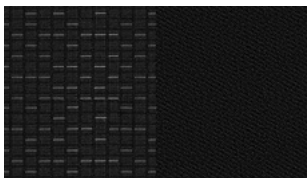

Black Caluma seat upholstery
(Standard)

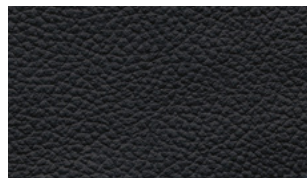

Black leatherette seat upholstery
(Optional on the Vito PRO
and SELECT)

Due to limitations of on-screen representation, the vehicle colours may differ in reality to the on screen images.

Equipment.



RETURN TO START

Key: ● Standard ○ Optional — Not available

Equipment	Description	Option code	Van PRO	Van SELECT	Crew Van PRO	Crew Van SELECT	Basic Price exc. VAT	Basic Price inc. VAT
Upgrade packages								
Mirrors	Mirror package The Vito Mirror package uses automatically dimming mirrors and electrically folding outside mirrors to increase the driving comfort and driving safety.	FP2	○	●	○	●	£450.00	£540.00
Security	Anti-theft protection package STANDARD ON ALL MODELS Thatcham category 1 approved. Includes cab interior and load-space monitoring with double locks, battery back-up siren and tow-away protection as standard on all Vito models.	FY1	●	●	●	●	£0.00	£0.00
Trim and Upholstery	Chrome interior appointment package The Chrome interior package further enhances the look of the driver's and front passenger's area with its trim elements on the dashboard and in the front doors.	FP4	○	●	○	●	£175.00	£210.00
Driver Assistance	Driving Assistance package Includes new features: Route based speed adjustment (JM3); Extended automatic start-up on motorways (JM2) and Active speed limit assist (JM4)	JS3	○	○	○	○	£1,200.00	£1,440.00
Heating and Ventilation	Winter package Includes the following: - Heated seat for driver (H16) - Heated windscreen washer system (F48)	F2W	○	○	○	○	£760.00	£912.00

Changes to individual option availability and combinations may occur depending on vehicle specification choices and the continuing evolution and adaptation of our product range. These changes may not be immediately reflected in this document as they occur, but will be introduced at the next revision opportunity.

Equipment.

● Standard ○ Optional — Not available



RETURN TO START

Equipment	Description	Option code	Van PRO	Van SELECT	Crew Van PRO	Crew Van SELECT	Basic Price exc. VAT	Basic Price inc. VAT
Exterior Features								
Bodywork	Chromed radiator grille Only available in conjunction with painted bumpers (CM2).	FK2	○	●	●	●	£175.00	£210.00
	Roof rails Maximum load of 150kg, when supported by three carrier bars.	D12	○	○	○	○	£500.00	£600.00
Fuel Tank	70L fuel tank	KB5	●	●	●	●	£0.00	£0.00
	Large AdBlue tank (24L)	KP7	●	●	●	●	£0.00	£0.00
Paint	Colour-coded front and rear bumpers	CM2	○	●	●	●	£435.00	£522.00
	Metallic paint Price of paint is dependent on colour.	n/a	○	●	○	●	£625.00	£750.00
Tyres	All-season tyres Compared to summer tyres, all-season tyres excel with better traction in wintry road conditions.	RM0	○	○	○	○	£225.00	£270.00
	Mud and slush tyres The M+S tyres can improve traction and lateral support in wintry road conditions, improving driving safety on snow, ice and mud.	RM1	○	○	○	○	£210.00	£252.00
	Summer tyres	RM7	●	●	●	●	£0.00	£0.00
Wheels	17" steel wheels Wheel: 6.5 J x 17 ET 51 Tyres: 225/55 R17	RS7	●	—	○	—	£0.00	£0.00
	17" Full wheel cover	RD8	●	—	○	—	£0.00	£0.00
	17" Alloy wheels (5 twin-spoke design) Wheel: 7 J x 17 ET 51 Tyres: 225/55 R17 or 235/55 R17	R1N	○	●	○	●	£830.00	£996.00
	17" Alloy wheels (20 spoke design) Painted in vanadium silver Wheel: 7 J x 17 ET 51 Tyres: 225/55 R 17	RK8	○	○	●	○	£830.00	£996.00
Interior Features								
Flooring	Velour floor mats The black velour floor mats visually enhance the cockpit and underscore the elegant, sporty wellness ambience in the vehicle.	VL2	○	○	○	○	£65.00	£78.00
Gearbox	6-speed manual transmission	GE1	●	—	—	—	£0.00	£0.00
	9G-TRONIC PLUS (automatic) Optional on	G43	○	●	●	●	£2,965.00	£3,558.00
Grab Handles	Grab handles for driver's and co-driver's doors	T75	○	●	○	●	£65.00	£78.00

Changes to individual option availability and combinations may occur depending on vehicle specification choices and the continuing evolution and adaptation of our product range. These changes may not be immediately reflected in this document as they occur, but will be introduced at the next revision opportunity.

Equipment.

● Standard ○ Optional — Not available



RETURN TO START

Equipment	Description	Option code	Van PRO	Van SELECT	Crew Van PRO	Crew Van SELECT	Basic Price exc. VAT	Basic Price inc. VAT
Interior Features (cont.)								
Heating and Ventilation	Diesel-powered auxiliary air heater The hot-water auxiliary heater indulges driver and passengers right from the start of the journey with cosy warmth.	H12	○	○	○	○	£1,285.00	£1,542.00
	Heated driver's seat	H16	○	○	○	○	£260.00	£312.00
	Heated dual co-driver's seat	H15	○	○	○	○	£260.00	£312.00
	TEMPMATIC air conditioning Cools and dehumidifies the air. Features a particulate filter to remove particles of dust and pollen from the outside air.	HH9	●	●	●	●	£0.00	£0.00
	THERMOTRONIC automatic climate control Automatically controls temperature, airflow and air distribution in 2 separate climate zones. If outside temperatures are very low, the residual heat mode (REST) can make use of the heat stored in the engine's coolant circuit for up to 30mins after the engine has been switched off.	HH4	○	○	○	○	£800.00	£960.00
Seating	Comfort driver's seat Single armrest on the side facing the front passenger; fore/aft adjustment (225mm in total, with 4.5mm intervals); stepless adjustment of the seat backrest angle; stepless seat height adjustment; comfort head restraint adjustable for angle and height.	SB1	●	●	●	●	£0.00	£0.00
	Comfort co-driver's seat Comfort driver and co-driver seat with inboard armrests and 4-way adjustable headrests. This deletes the double co-driver seat and therefore limits the cab area to two occupants.	SB2	○	○	○	○	£0.00	£0.00
	Double co-driver's seat Bench seat with 2x three-point seat belts, height-adjustable head restraints, and a fixed 17° backrest.	S23	●	●	●	●	£0.00	£0.00
	Driver's seat plus with level sitting surface	SF3	○	○	○	○	£0.00	£0.00
	Co-driver's seat plus with level sitting surface	SF4	○	○	○	○	£0.00	£0.00
	Lumbar support for driver's seat Electropneumatically operated dual-cushion 4-way lumbar support, adjusted using a switch on the outer side of the seat cushion. The position of the air cushions can also be adjusted for height.	SE5	●	●	●	●	£0.00	£0.00
	Lumbar support for co-driver's seat Not compatible with Double co-driver seat (S23)	SE4	○	○	○	○	£0.00	£0.00

Changes to individual option availability and combinations may occur depending on vehicle specification choices and the continuing evolution and adaptation of our product range. These changes may not be immediately reflected in this document as they occur, but will be introduced at the next revision opportunity.

Equipment.

● Standard ○ Optional — Not available



RETURN TO START

Equipment	Description	Option code	Van PRO	Van SELECT	Crew Van PRO	Crew Van SELECT	Basic Price exc. VAT	Basic Price inc. VAT
Interior Features (cont.)								
Steering Wheel	Height and rake adjustable steering wheel Manually adjustable by 4.8° in tilt and 60mm in/out.	CL1	●	●	●	●	£0.00	£0.00
	Multifunction steering wheel	C6L	●	●	●	●	£0.00	£0.00
	Leather steering wheel	CL3	○	●	●	●	£225.00	£270.00
Storage	Centre console with stowage compartment	FF1	○	○	○	○	£125.00	£150.00
	Locking glove compartment Lock operated using the manual emergency key which is integrated within the electronic ignition key.	F66	●	●	●	●	£0.00	£0.00
Trim and Upholstery	Black Caluma seat upholstery	VF4	●	●	●	●	£0.00	£0.00
	Black leatherette seat upholstery The black man-made leather lends the interior a comfortable aspect and impresses with its low-maintenance surface.	VU9	○	○	○	○	£65 on Van £145 on Crew	£78.00 on Van £174.00 on Crew
Technology, Software & Electrics								
Audio Entertainment and Navigation	MBUX multimedia system	E7M	●	●	●	●	£0.00	£0.00
	2-way loudspeakers, front	EL8	●	●	—	—	£0.00	£0.00
	2-way loudspeakers, front and rear	EL9	—	—	●	●	£0.00	£0.00
	Navigation	E1E	○	○	○	○	£890.00	£1,068.00
	Smartphone Integration package	E4S	○	●	○	●	£425.00	£510.00
	Dashcam	JK9	○	○	○	○	£160.00	£192.00
	Wireless charging system for mobile devices	E10	○	○	○	○	£105.00	£126.00
Keys	Two additional master keys	FZ9	○	○	○	○	£175.00	£210.00
Driver's Assistance & Safety								
Airbags	Driver's airbag	n/a	●	●	●	●	£0.00	£0.00
	Co-driver airbag	SA6	●	●	●	●	£0.00	£0.00
	Driver thorax-pelvis sidebag	SH1	●	●	●	●	£0.00	£0.00
	Co-driver thorax-pelvis sidebag	SH2	●	●	●	●	£0.00	£0.00

Changes to individual option availability and combinations may occur depending on vehicle specification choices and the continuing evolution and adaptation of our product range. These changes may not be immediately reflected in this document as they occur, but will be introduced at the next revision opportunity.

Equipment.

● Standard ○ Optional – Not available



RETURN TO START

Equipment	Description	Option code	Van PRO	Van SELECT	Crew Van PRO	Crew Van SELECT	Basic Price exc. VAT	Basic Price inc. VAT
	Windowbags for driver and co-driver Windowbags on the driver's and front-passenger's side can contribute to reducing the risk of head and facial injuries in the event of severe accidents involving major side-on impact.	SH9	○	○	○	○	£590.00	£708.00
Driver's Assistance & Safety (cont.)								
Driver's Assistance (cont.)	Active Brake ASSIST Can detect the danger of a collision with the vehicle ahead, stationary traffic and pedestrians by reacting with a visual and audible warning – braking automatically if there is no driver reaction.	BA3	●	●	●	●	£0.00	£0.00
	Active Distance ASSIST DISTRONIC Automatically maintains the distance to vehicles in front. The system accelerates the vehicle by itself and brakes it with a maximum of half the vehicle's braking power in order to maintain a safe distance.	ET4	○	○	○	○	£1,130.00	£1,356.00
	ATTENTION ASSIST With the help of numerous parameters, the ATTENTION ASSIST function can detect typical signs of drowsiness and warn the driver.	JW8	●	●	●	●	£0.00	£0.00
	Comfort overhead control panel LED interior lighting including cab downlighting and co-/driver reading lamps; also includes a convenient spectacles compartment.	LC4	●	●	●	●	£0.00	£0.00
	Cruise Control Includes speed limiter function. Operated via a lever ergonomically positioned on the left of the steering column.	MS1	●	●	●	●	£0.00	£0.00
	Headlight assistant A windscreen sensor continuously monitors light conditions and automatically switches the dipped beams on/off upon reaching pre-defined limits.	LA2	●	●	●	●	£0.00	£0.00
	Active Lane Keeping Assist Warns the driver if lane markings are crossed unintentionally.	JB4	●	●	●	●	£0.00	£0.00
	Blind Spot Assist	JA7	●	●	●	●	£0.00	£0.00
	Intelligent Speed Assist	JS2	●	●	●	●	£0.00	£0.00
	Traffic Sign Assist	JA9	○	○	○	○	£0.00	£0.00
	Tyre pressure monitoring, wireless Monitors air pressure in all 4 wheels. Slight pressure variances generate a visual warning. Sudden, extreme pressure losses trigger an additional acoustic warning.	RY2	●	●	●	●	£0.00	£0.00
Parking	Reversing camera	FR8	●	–	●	–	£0.00	£0.00
	Parking package with reversing camera	JB7	○	●	○	●	£1,285.00	£1,542.00

Changes to individual option availability and combinations may occur depending on vehicle specification choices and the continuing evolution and adaptation of our product range. These changes may not be immediately reflected in this document as they occur, but will be introduced at the next revision opportunity.

Equipment.

● Standard ○ Optional – Not available



RETURN TO START

Equipment	Description	Option code	Van PRO	Van SELECT	Crew Van PRO	Crew Van SELECT	Basic Price exc. VAT	Basic Price inc. VAT
	Reversing warning device The reverse warning alarm warns pedestrians and other road users audibly of the reversing vehicle and thereby enhances their safety.	JW0	○	○	○	○	£115.00	£138.00
Driver's Assistance & Safety (cont.)								
Safety Equipment	Accident recovery and breakdown management The vehicle will automatically call the Mercedes-Benz Customer Assistance Center at a press of a button to provide the driver with professional help in the event of an emergency.	EY6	●	●	●	●	£0.00	£0.00
	PRE-SAFE The PRE-SAFE® anticipatory occupant protection system can detect critical driving situations at an early stage and initiate preventive protection measures.	JP1	○	○	○	○	£450.00	£540.00
	First aid kit	Y10	○	○	○	○	£65.00	£78.00
	Fire extinguisher 1kg	YF7	○	○	○	○	£175.00	£210.00
	Warning triangle	Y44	○	○	○	○	£0.00	£0.00
	Jack	Y36	○	○	○	○	£75.00	£90.00
	Spare Wheel with Jack	RR6	●	●	●	●	£0.00	£0.00
Lighting								
Lighting	MULTIBEAM LED with Highbeam Assist PLUS	L45	○	●	○	●	£2,305.00	£2,766.00
	LED tail lamps, brake lamps and indicators	LG4	–	–	○	●	£0.00	£0.00
	Blinker lights on rear of roof The additional turn signal lamps on rear of roof improve the visibility of the vehicle, thus enhancing perceptual safety.	L84	○	○	○	○	£195.00	£234.00
	Interior ambient lighting	LP1	○	●	○	●	£310.00	£372.00
	LED lightstrip in load compartment	LC2	○	●	○	○	£125.00	£150.00
Loading & Towing								
Bulkhead	Full-width partition with 1 window The full-width partition wall on the B-pillar with window allows a view into the cargo area or the view to the rear and shields the driver's compartment from the load compartment.	D51	○	○	–	–	£430.00	£516.00
Gross Vehicle Weight (GVW)	Gross vehicle weight 2.8T	XG6	○	○	○	○	£0.00	£0.00
	Gross vehicle weight 3.0T	X3G	●	●	●	●	£0.00	£0.00
Ground clearance	Increased ground clearance The increased ground clearance by 10mm is particularly beneficial on rough roads or when driving over ramps.	C14	○	○	–	–	£240.00	£288.00

Changes to individual option availability and combinations may occur depending on vehicle specification choices and the continuing evolution and adaptation of our product range. These changes may not be immediately reflected in this document as they occur, but will be introduced at the next revision opportunity.

Equipment.

● Standard ○ Optional — Not available



RETURN TO START

Equipment	Description	Option code	Van PRO	Van SELECT	Crew Van PRO	Crew Van SELECT	Basic Price exc. VAT	Basic Price inc. VAT
Loading and Towing (cont.)								
Load Area	Interior wood panelling to roof height in load compartment The 5mm-thick wooden panelling of the vehicle sidewalls extending up to roof height protects the sheet metal in the load compartment from damage caused by the cargo.	VA2	○	○	—	—	£505.00	£606.00
	Wood load flooring Multiple-bonded 10mm-thick weatherproof plywood floor, coated with hard-wearing phenolic resin film, and featuring a non-slip textured grid surface.	V43	●	●	○	○	£0.00	£0.00
Towing Equipment	Trailer coupling, rigid coupling head	Q22	○	○	○	○	£490.00	£588.00
	Trailer coupling ball headed removable	Q50	○	○	○	○	£915.00	£1,098.00
	Electrical components for trailer socket	E57	●	●	●	●	£0.00	£0.00
	Trailer load 2,500kg* The updated towing load of 2,500kg makes it possible to tow up to 500kg additional load. * Requires 9G-TRONIC	QA4	○	○	○	○	£145.00	£174.00
Mirrors & Windows								
Mirrors	Electrically folding wing mirrors Fold-in/out function is operated via controls in the driver door.	F64	○	●	○	●	£330.00	£396.00
	Heated, electrically adjustable wing mirrors Mirror heating reduces condensation in cold weather and prevents icing-up of the mirrors. The exterior mirrors are heated automatically upon vehicle start when the outside temperature is low or when the rear defrost function is activated.	F68	●	●	●	●	£0.00	£0.00
	Illuminated vanity mirrors for sun visors	FS5	○	●	○	●	£170.00	£204.00
Windows	Black-tinted windows in rear 90% window tint offers attractive thermal and privacy protection. Applies to all windows after the B-pillar.	W70	○	○	○	○	£0.00	£0.00
	Heat-insulating glass Windscreen (laminated glass), side windows and rear window (single-pane safety glass) are tinted green, reducing the sunlight's heating effect on the interior.	H20	●	●	●	●	£0.00	£0.00
	Heated windscreen washer system	F48	○	○	○	○	£245.00	£294.00
	Sliding window in left sliding door	W18	○	○	○	○	£530 on Van £355 on Crew	£636.00 on Van £426.00 on Crew
	Sliding window in right sliding door	W19	○	○	○	○	£530 on Van £355 on Crew	£636.00 on Van £426.00 on Crew

Changes to individual option availability and combinations may occur depending on vehicle specification choices and the continuing evolution and adaptation of our product range. These changes may not be immediately reflected in this document as they occur, but will be introduced at the next revision opportunity.

Engine and gearbox.



RETURN TO START

Engine specifications	114	116	119
Fuel	Diesel	Diesel	Diesel
Cylinder arrangement	4, in-line	4, in-line	4, in-line
Cubic capacity	1,950cc	1,950cc	1,950cc
Turbocharger	Two-stage turbocharger with variable turbine geometry	Two-stage turbocharger with variable turbine geometry	Two-stage turbocharger with variable turbine geometry
EU exhaust emission standard	Euro 6d	Euro 6d	Euro 6d
Output, max.	136hp @ 3,600-4,200rpm	163hp @ 3,800-4,200rpm	190hp @ 3,800-4,200rpm
Torque, max.	330Nm @ 1,250-2,400rpm	380Nm @ 1,250-2,400rpm	440Nm @ 1,350-2,600rpm
Fuel tank capacity	70L	70L	70L
AdBlue® capacity	24L	24L	24L
Diesel Particulate Filter (DPF)	●	●	●
6-speed manual gearbox	●	—	—
9G-TRONIC automatic gearbox	○	●	●
Driven Axle	RWD	RWD	RWD
Alternator	14V/250A with Alternator Management (battery charged during braking and overrun)	14V/250A with Alternator Management (battery charged during braking and overrun)	14V/250A with Alternator Management (battery charged during braking and overrun)
Battery	12 V/95Ah (AGM)	12 V/95Ah (AGM)	12 V/95Ah (AGM)

● Standard ○ Optional — Not available

Fuel consumption, performance and CO₂ emissions.



RETURN TO START

WLTP Fuel Consumption (l/100km/MPG)

Model	CO ₂ emissions (g/km)	Combined	Low (Extra Urban)	Medium (Urban)	High (Rural)	Extra High (Motorway)
Panel Van - PRO						
114 Van PRO L2	188	7.2/ 39.2	8.9/ 31.7	6.8/ 41.5	6.1/ 46.3	7.6/ 37.1
114 Van PRO L3	189	7.2/ 39.2	9.0/ 31.3	6.8/ 41.5	6.2/ 45.5	7.7/ 36.6
Panel Van - SELECT						
116 Van SELECT L2	189	7.2/ 39.2	8.6/ 32.8	7.1/ 39.7	6.2/ 45.5	7.7/ 36.6
116 Van SELECT L3	191	7.3/ 38.6	8.7/ 32.4	7.1/ 39.7	6.3/ 44.8	7.7/ 36.6
119 Van SELECT L2	193	7.4/ 38.1	9.0/ 31.3	7.2/ 39.2	6.3/ 44.8	7.7/ 36.6
119 Van SELECT L3	195	7.4/ 38.1	9.1/ 31.0	7.3/ 38.6	6.4/ 44.1	7.8/ 36.2

WLTP Fuel Consumption (l/100km/MPG)

Model	CO ₂ emissions (g/km)	Combined	Low (Extra Urban)	Medium (Urban)	High (Rural)	Extra High (Motorway)
Crew Van - PRO						
116 Crew Van PRO L2	192	7.3/ 38.6	8.8/ 32.1	7.2/ 39.2	6.3/ 44.8	7.7/ 36.6
116 Crew Van PRO L3	193	7.4/ 38.1	8.8/ 32.1	7.2/ 39.2	6.3/ 44.8	7.8/ 36.2
119 Crew Van PRO L2	196	7.5/ 37.6	9.2/ 30.7	7.4/ 38.1	6.4/ 44.1	7.8/ 36.2
119 Crew Van PRO L3	197	7.5/ 37.6	9.2/ 30.7	7.4/ 38.1	6.4/ 44.1	7.8/ 36.2
Crew Van - SELECT						
119 Crew Van SELECT L2	196	7.5/ 37.6	9.2/ 30.7	7.4/ 38.1	6.4/ 44.1	7.8/ 36.2
119 Crew Van SELECT L3	197	7.5/ 37.6	9.2/ 30.7	7.4/ 38.1	6.5/ 43.4	7.9/ 35.7

All figures are based on a standard specification. The choice of additional factory options may affect CO₂ emissions and corresponding Road Fund Licence. The indicated values were determined according to the prescribed measurement method - Worldwide Harmonised Light Vehicle Test Procedure (WLTP). Figures shown may include options which are not available in the UK. Figures shown are for comparability purposes; only compare with other vans tested to the same technical procedures. Figures may not reflect real life driving results, which will depend upon a number of factors including factory-fitted options, accessories fitted (post registration), variations in weather, driving styles and vehicle load.

Further information about the test used to establish fuel consumption and CO₂ figures can be found at <https://www.mercedes-benz.co.uk/vans/en/WLTP>

Weights and payloads.



RETURN TO START

Model	Unladen Weight (Kg)	Gross Vehicle Weight (Kg)	Payload (Kg)	Gross Train Weight (Kg)
Panel Van				
114 Van PRO L2	2,090	3,000	910	5,000
114 Van PRO L3	2,117	3,000	883	5,000
116 Van SELECT L2	2,155	3,000	845	5,000
116 Van SELECT L3	2,182	3,000	818	5,000
119 Van SELECT L2	2,168	3,000	832	5,000
119 Van SELECT L3	2,195	3,000	805	5,000

Model	Unladen Weight (Kg)	Gross Vehicle Weight (Kg)	Payload (Kg)	Gross Train Weight (Kg)
Crew Van				
116 Crew Van PRO L2	2,210	3,000	790	5,000
116 Crew Van PRO L3	2,237	3,000	763	5,000
119 Crew Van PRO L2	2,223	3,000	777	5,000
119 Crew Van PRO L3	2,250	3,000	750	5,000
119 Crew Van SELECT L2	2,234	3,000	766	5,000
119 Crew Van SELECT L3	2,261	3,000	739	5,000

Please note: The stated payload weights are correct according to type approval data. The specific payload values for UK supplied vehicles may differ. The figure quoted only accounts for equipment which is included in the UK product offer as standard. Please speak to a dealer for final vehicle configurations and weights once all options and accessories have been added.

Dimensions.



RETURN TO START

PANEL VAN L2

Wheelbase	Wheelbase length	3,200mm
	Turning circle	11.8m
	Track circle	11m
	Front track width	1,666mm
	Rear track width	1,646mm
Vehicle	Length	5,140mm
	Height (unladen)	1,915mm
	Width (inc. wing mirrors)	2,244mm
	Ground clearance	125mm
Load compartment	Length	2,831mm*
	Load volume	6.0m ³
	Max. width	1,709mm
	Width between wheel arches	1,270mm
	Height	1,252mm
	Rear loading height (step height from ground to load floor)	558mm

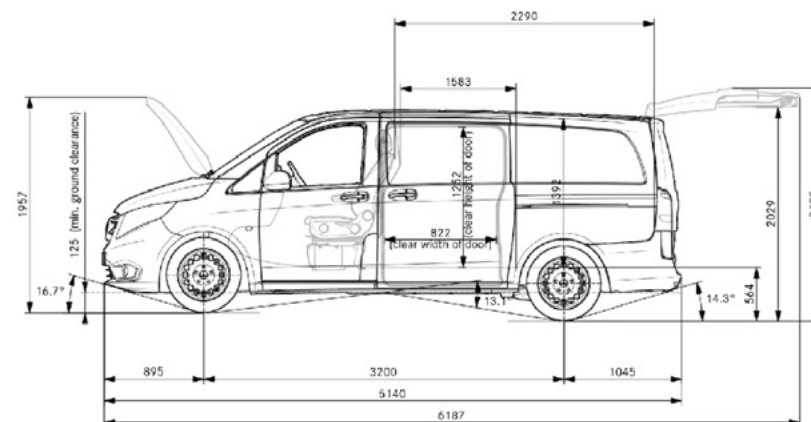
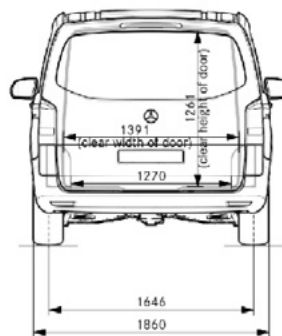
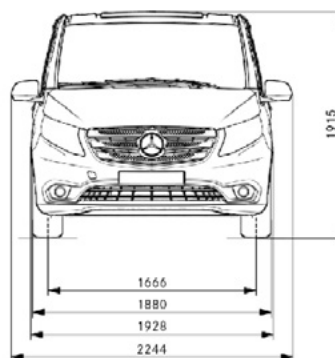

* Measured on vehicle floor and includes 370mm for the space beneath the front seats.

Dimensions.



RETURN TO START

PANEL VAN L3

Wheelbase	Wheelbase length	3,430mm
	Turning circle	12.5m
	Track circle	12m
	Front track width	1,666mm
	Rear track width	1,646mm
Vehicle	Length	5,370mm
	Height (unladen)	1,916mm
	Width (inc. wing mirrors)	2,244mm
	Ground clearance	125mm
	Load compartment	Length
Load volume		6.6m ³
Max. width		1,709mm
Width between wheel arches		1,270mm
Height		1,252mm
Rear loading height (step height from ground to load floor)		558mm

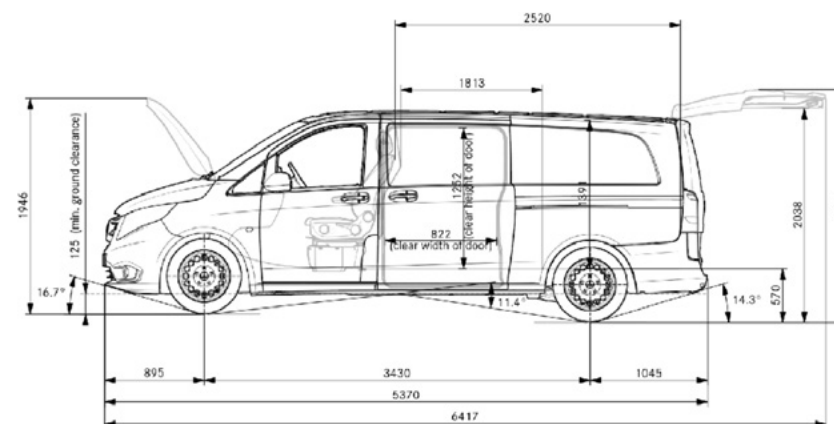
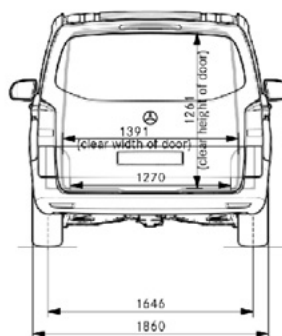
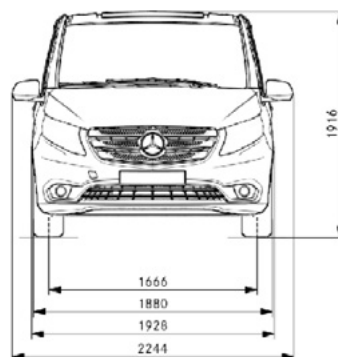

* Measured on vehicle floor and includes 370mm for the space beneath the front seats.

Dimensions.



RETURN TO START

CREW VAN L2		
Wheelbase	Wheelbase length	3,200mm
	Turning circle	11.8m
	Track circle	11m
	Front track width	1,666mm
	Rear track width	1,646mm
Vehicle	Length	5,140mm
	Height (unladen)	1,908mm
	Width (inc. wing mirrors)	2,244mm
	Ground clearance	125mm
Load compartment	Length	1,664mm*
	Load volume	3.6m ³
	Max. width	1,709mm
	Width between wheel arches	1,270mm
	Height	1,252mm
	Rear loading height (step height from ground to load floor)	558mm

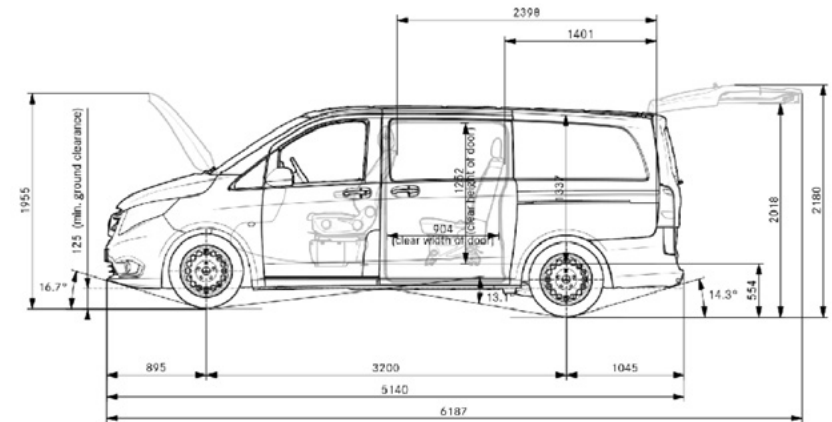
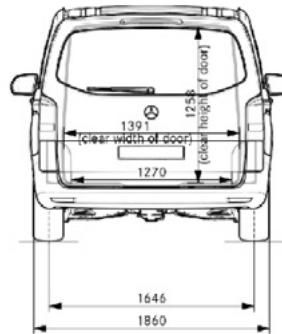
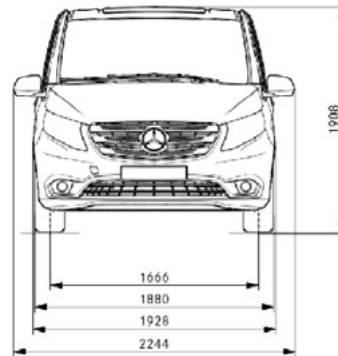

* Measured on vehicle floor and includes 370mm for the space beneath the front seats.

Dimensions.



RETURN TO START

CREW VAN L3		
Wheelbase	Wheelbase length	3,430mm
	Turning circle	12.5m
	Track circle	12m
	Front track width	1,666mm
	Rear track width	1,646mm
Vehicle	Length	5,370mm
	Height (unladen)	1,910mm
	Width (inc. wing mirrors)	2,244mm
	Ground clearance	125mm
Load compartment	Length	1,894mm*
	Load volume	4.1m ³
	Max. width	1,709mm
	Width between wheel arches	1,270mm
	Height	1,252mm
	Rear loading height (step height from ground to load floor)	558mm

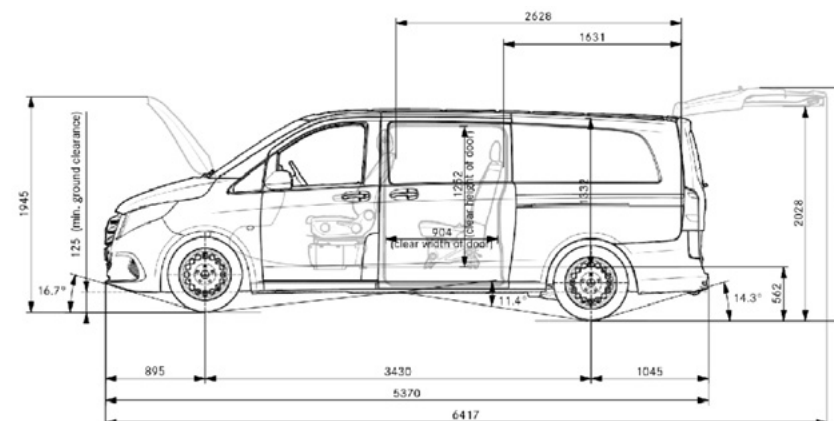
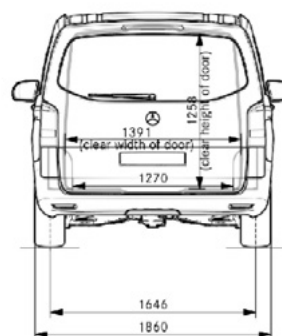
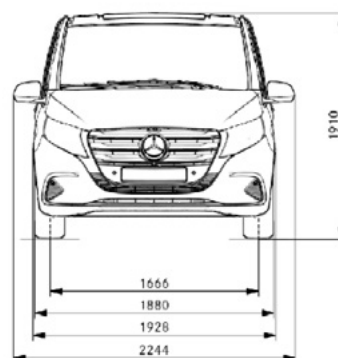

* Measured on vehicle floor and includes 370mm for the space beneath the front seats.

List prices.



RETURN TO START

Model	Transmission	Basic Recommended Retail Price (Ex. VAT)	Basic Recommended Retail Price (Inc. VAT)
Panel Van – PRO			
114 Van L2 PRO	6-speed (manual)	£32,850	£39,420
114 Van L3 PRO	6-speed (manual)	£33,895	£40,674
Panel Van – SELECT			
116 Van L2 SELECT	9G-TRONIC (auto)	£41,690	£50,028
116 Van L3 SELECT	9G-TRONIC (auto)	£42,735	£51,282
119 Van L2 SELECT	9G-TRONIC (auto)	£43,170	£51,804
119 Van L3 SELECT	9G-TRONIC (auto)	£44,215	£53,058

Model	Transmission	Basic Recommended Retail Price (Ex. VAT)	Basic Recommended Retail Price (Inc. VAT)
Crew Van – PRO			
116 Crew Van L2 PRO	9G-TRONIC (auto)	£40,385	£48,462
119 Crew Van L2 PRO	9G-TRONIC (auto)	£40,860	£49,032
116 Crew Van L3 PRO	9G-TRONIC (auto)	£41,430	£49,716
119 Crew Van L3 PRO	9G-TRONIC (auto)	£41,905	£50,286
Crew Van – SELECT			
119 Crew Van L2 SELECT	9G-TRONIC (auto)	£44,535	£53,442
119 Crew Van L3 SELECT	9G-TRONIC (auto)	£45,580	£54,696

This vehicle is predominantly designed for the purpose of carrying goods. If you intend to use or modify the vehicle for commercial and private use then it could be classified for tax purposes as a car and therefore subject to increased BIK and RFL liabilities.

This document is for guidance only and must be used in conjunction with a configuration tool prior to final specification decisions and vehicle quotations being prepared and accepted. List prices are quoted ex-factory unless otherwise stated. Delivery charges excluding VAT will be added to model prices quoted in this document. Prices based on standard finish paint choice. Mercedes-Benz Vans UK and authorised Dealers reserve the right to alter specification and vary prices without notice. The availability of options may depend on the chosen base vehicle and other optional equipment specified, and should be confirmed with your Mercedes-Benz Vans Dealer prior to order placement. VAT is calculated at the standard rate of 20%. Mercedes-Benz Vans UK Ltd, Tongwell, Milton Keynes MK15 8BA.



RETURN TO START

Mercedes-Benz Finance Options.

Choose an agreement that suits you with Mercedes-Benz Finance.

At Mercedes-Benz Finance we understand what it takes to run a modern-day business. Because of this, we have a number of finance options ready to suit your business needs.

Agility (Personal Contract Plan)

Agility (Personal Contract Plan) is our most flexible method of financing. You drive the vehicle over a fixed term, with fixed monthly payments. And at the end of the agreement, you decide whether you want to:

- Buy another Mercedes-Benz.
- Purchase your van by paying the Optional Purchase payment (balloon) and Option to Purchase Fee.
- Return it to us.

As a business customer, your vehicle can also appear as an asset on your balance sheet.

[For more information about Agility.](#)

Hire Purchase

A straightforward route to ownership. This product allows you to spread the overall cost of your Mercedes-Benz over a fixed term.

As a business customer, your vehicle can also appear as an asset on your balance sheet.

[For more information on Hire Purchase.](#)

Operating Lease

A solution for those who want to drive one of our vehicles over a specific term, with fixed monthly rentals and without the commitment of ownership of the vehicle.

As a business customer, your vehicle can also appear as an asset on your balance sheet.

[For more information on Operating Lease.](#)

Contract Hire

A solution for those who want to drive one of our vans over a specific term, with fixed monthly rentals and without the need to commit to ownership of the vehicle. This includes the cost of your Vehicle Excise Duty (also known as Road Fund Licence) for the duration of your agreement.

As a business customer, your vehicle can also appear as an asset on your balance sheet.

[For more information on Contract Hire.](#)

Finance Lease

Finance Lease gives you the ability to enjoy driving a Mercedes-Benz Van for a fixed time without the option of ownership. With this option you lease your vehicle for a fixed period and for fixed monthly rentals.

As a limited company or PLC customer, your vehicle can also appear as an asset on your balance sheet.

[For more information on Finance Lease.](#)

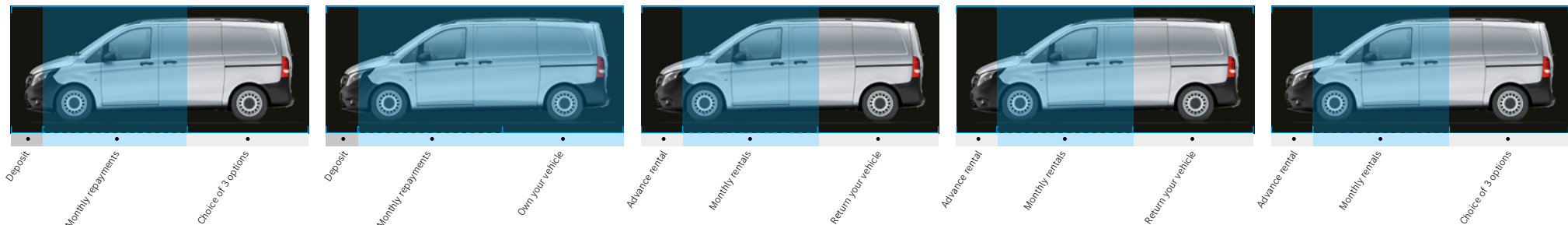

[For more information about our finance options](#)

Mercedes me connectivity.



RETURN TO START

Monitor your van's status, location and security via your smartphone.



ASSISTANCE & AFTERCARE		FREE
Telediagnosics & Maintenance Management	Receive a notification when wear is detected on diagnostic-capable parts such as brake pads and get advance notice of when a service is due allowing you to plan your workshop visit well in advance to minimise any impact on your business.	
Remote Vehicle Diagnostics	Your Dealer can assess your van's condition remotely allowing them to check if any other repairs are required ahead of a service.	
Accident Recovery & Breakdown Management	Once an emergency call has been resolved or if you request breakdown assistance, further support is offered to help recover your van or to tow it to a Mercedes-Benz Service outlet.	
Software updates	Over-the-air software updates are sent directly to your van's head unit. This means you'll always know your software is up to date and you'll save time by avoiding additional workshop visits.	
VEHICLE SUPERVISION		FREE FOR 3 YEARS
Vehicle Tracker	See your van's location on the map in your app, making it easy to call or message your driver and re-route them to fit in another delivery or pick-up if a quicker route is available. The tracker is factory fitted equipment so it can't be easily removed if stolen.	
Parked Vehicle Locator	If you're within 1 mile of your van's parked location, the app can generate the most convenient walking route - very handy if you're in unfamiliar surroundings and on a busy schedule.	
REMOTE ACCESS		FREE FOR 3 YEARS
Remote Retrieval of Vehicle Status	Use your app to check on fuel level, tyre pressure, mileage and trip information. Not only does this help you plan your day's journeys, it can save you admin time on tasks such as logging your mileage for expenses.	
Remote Door Locking & Unlocking	The app allows you to check if your van is locked. If you lock your keys in the van or need to give another driver access, you can do it via the app, from any distance away. For added peace of mind, you'll receive an email notification when your vehicle is unlocked.	

Mercedes-Benz Approved Used vans. Get used to more...



RETURN TO START

More choice. More confidence. More quality – and more added extras.

As a Mercedes-Benz Approved Used customer, you'll have complete peace of mind as every van offers the same commitment to quality and workmanship as new and comes with:



Minimum 12-month warranty*
PLUS the option of monthly
top-ups, up to 24 months*



Free MOT test failure cover**
covering you for £1,500

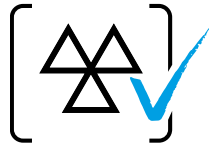

Minimum
3 months MOT

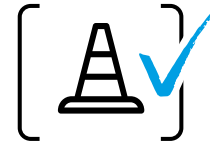

Free 24/7 breakdown cover
and roadside assistance^



Free 7-day driveway
van insurance^^



Comprehensive
multi-point vehicle check



Discounted
service plans

▶ [View our Dealer Networks Approved Used van stock](#)

*Warranty eligible up to 200,000 miles on approved used Mercedes-Benz Vans with less than 150,000 miles at point of sale. Top ups are to a maximum of 24 months. For full T&Cs, please speak to your preferred sales representative. ** MOT cover redeemable per 12-months warranty. £1,500 claims limit. For more information, please speak to your preferred sales representative. ^ Free for 12 months initially and renewed at each service, if serviced by MB according to service intervals for up to 30 years from when the vehicle was first registered. For a full list of exclusions and all product terms please visit mbvans.co.uk/mobilovan ^^ Available on single vehicle policies only and applicable on Vehicles up to 3.5t only. For full terms and conditions, please consult your local Dealer. Mercedes-Benz Van Insurance is a trading name of Mercedes-Benz Insurance Services UK Limited. Prices are correct at time of going to press 07/2023. All prices are subject to any fiscal or legislative changes.



Approved
Used



What is an Approved Used van?

- Is no older than 6 years old
- Is eligible for one of our flexible finance plans
- Has less than 150,000 miles on the clock

▶ [Find more information and our latest Approved Used offers](#)

Ready to go electric?

▶ [Find our latest Approved Used Electric offers](#)

Service24: Demand more

The most comprehensive Aftercare package – for businesses that demand more.

Our 120-strong Dealer network works around the clock to service and maintain your vans and keep your business moving. It all adds up to more value, more flexibility and more confidence that you'll only find at an authorised Mercedes-Benz Dealer.



› Flexible servicing and maintenance

Book your service online or by telephone, and as well as a standard 'drop and go' service with a courtesy van, you'll also get:

- Early bird, late night and weekend slots
- Mobile service
- Overnight service
- Collect & deliver service
- Express 1hr service
- Electric van service.

[Find out more about service and repairs](#)



› Flexible ways to pay and save

With fixed, transparent national pricing there are no surprises with our services and repairs – plus you can fix, spread and reduce your service and maintenance costs, and ease your cashflow at the same time, with a payment plan.

- Pay as You Go
- ServiceCare Maintenance
- ServiceCare Flex (specifically for fleets)
- ServiceCare Complete.

[Find out more about service options](#)

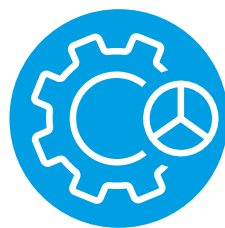

› 3-year unlimited mileage warranty

Available on every new van, all service and maintenance – and any work required – is covered by your 3-year unlimited mileage warranty, and is only undertaken by Mercedes-Benz trained technicians using Mercedes-Benz GenuineParts.

[Find out more about warranties](#)



› Free breakdown cover & roadside assistance*

Every van comes with free Europe-wide breakdown cover – MobiloVan. And with 3 years' cover on new vehicles for driver mishaps, no one goes further to keep your business moving.

- Trained technicians using only Mercedes-Benz GenuineParts
- Forward travel of load and crew is covered
- Driver mishap cover for the first 3 years, including out of charge cover or empty fuel tanks.

[Find out more about MobiloVan](#)

*For a full list of exclusions and all product terms please visit www.mercedes-benz.co.uk/vans/en/Owners/MobiloVan

The Mercedes-Benz Vito

27

Vito Panel Van PRO	Vito Panel Van SELECT	Vito Crew Van PRO	Vito Crew Van SELECT	Colours and upholstery	Equipment	Engine & gearbox	Fuel consumption	Weights and payloads	Dimensions	List prices	Mercedes me connectivity	Approved Used	Service24
--------------------	-----------------------	-------------------	----------------------	------------------------	-----------	------------------	------------------	----------------------	------------	-------------	--------------------------	---------------	-----------

